



FA464DR

64 Transmitter / 16-Output Receiver Installation Instructions 02039F

Document revision history / Notes		
Rev. Level	Description	Date
B	Create F:\Eng\parts\02039\E02039B.doc from P:\Master.dox\FA_dox\FA464.doc (pre-ECN)	6/01
C	Create F:\Eng\parts\02039\02039C.doc from F:\Eng\parts\02039\E02039B.doc (ECN release version)	7/25/01
D	Replace ISO logo	7/25/01
E	Revise per ECN 2259	10/24/02
F	Add wire gauge p. 4; delete FA200/FA200W p.12	11/21/03

Important Notes

- ▲ This product is designed to be installed and maintained by professional security technicians.
- ▲ Unless specifically noted, Inovonics products are intended for indoor use. This receiver is intended for use with *indoor* security systems. Use in outdoor applications may impair performance.
- ▲ Test system regularly.



FA464DR

64-Transmitter, 16-Relay Output Receiver

The FA464DR receiver has 16 Form C relay outputs, plus a global fault relay output.

Installers should note that alarm relay terminals are mounted so that normally open or normally closed terminal positions are side-by-side as shown in Figure 1.

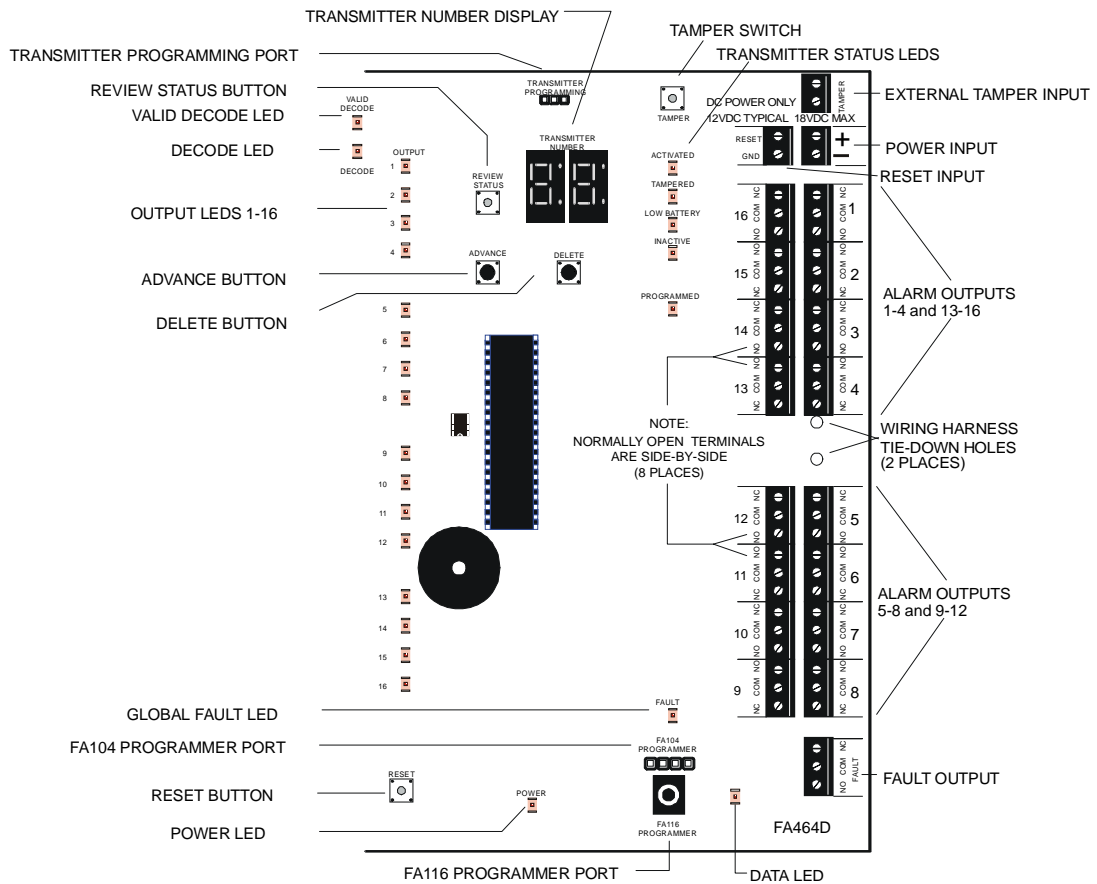

Figure 1

Note: References in this manual to features shown in Figure 1 will be printed in ***bold italics***.

Features of the FA464DR include:

- Full supervision of up to 64 FA transmitters.
- The FA464DR has 16 Form C **Alarm Output Relays**, plus a global **Fault Output Relay**.
- Transmitter, receiver and output options are factory assigned. They may be changed with the FA116 Executive Programmer or with the FA104 (upgraded C104) programmer.
- Intelligent global fault output for tamper, low battery and inactive transmitters. For example, if one of the alarm outputs is assigned to monitor low battery faults, the fault output automatically becomes tamper and inactive only.
- Manual and/or electronic reset of the receiver.
- Factory default programming: "Alarm" and "Inactive" outputs are programmed to follow transmitter status; "Tamper" and "Low battery" outputs are latching. Latched outputs require the receiver to be reset.
- Simple restoral to factory defaults.
- Automatic exit from programming after 4 minutes of inactivity.
- **Transmitter Status LEDs** show transmitter activation, tamper, low battery and inactive.
- The **Programming LED** blinks when the point IS NOT programmed, is on steady when the point IS programmed.

Technical Specifications:

Dimensions (housing):	11" x 8.5" x 1.75"
Weight:	34 oz
Environmental:	
Operating temperature:	32°-140°F (0°-60°C)
Relative Humidity:	90% (non-condensing)
Electrical:	
Power Requirement:	12-17 VDC, 980mA
Minimum:	60 Ma
Output relay rating:	1A @ 28 VDC, 0.5A @ 30 VAC (resistive)
Wire gauge:	14-22 AWG
Receiver:	
Type:	frequency-hopping spread spectrum
Operating frequency:	902-928 MHz

Installation:

Power: Supply power and ground to designated terminals on the **Power Input** terminals.

Note: To power the FA464DR directly from an AC power source, Inovonics recommends a power supply that is UL listed for use with "Burglar Alarm Systems."

Mounting: Use supplied hardware to attach FA464DR housing to wall or surface.

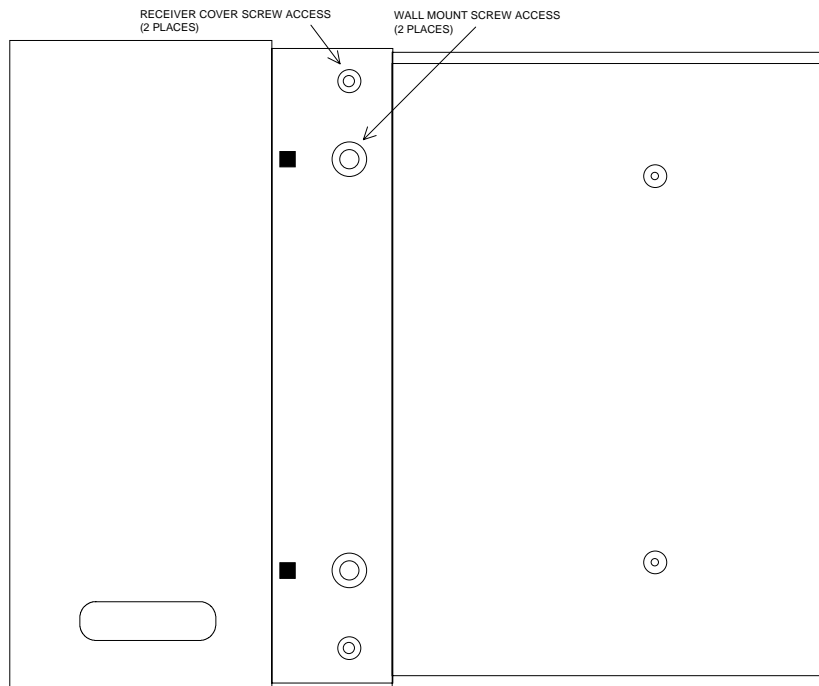

Figure 2

Connecting to a panel: When the FA464DR will be used with a hardwire security panel, the panel will typically supply power and ground to the FA464DR (if the power supply provides the required current).

Typical connections between the FA464DR and a hardwire panel:

The installer wires the relay common terminal to the panel Zone Return, and wires either the Normally Open or the Normally Closed terminal of the relay to the panel Zone input terminal.

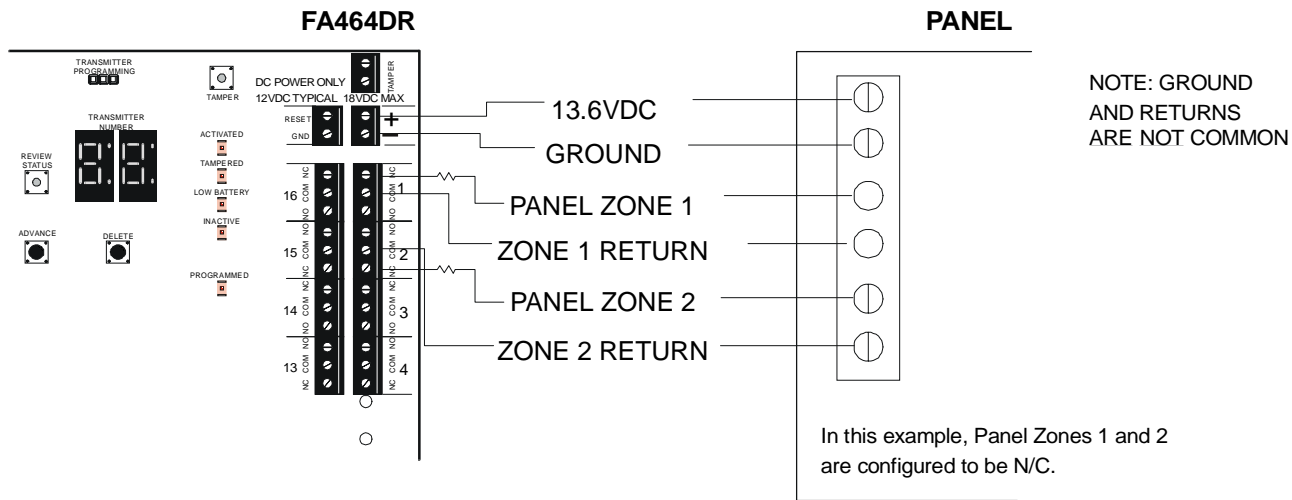

Figure 3

Programming transmitters:

Without the FA116 programmer:

1. Refer to Appendix A to determine available default parameters.
2. Select a point number which matches desired transmitter parameters.
3. Press the **Advance Button** on the FA464DR until the **Transmitter Number Display** shows the desired transmitter number. (Hold down the **Advance Button** for auto repeat.) The **Programming LED** will blink if the point has not been programmed. If a transmitter has already been programmed to that channel, the LED will be on steady.
4. Connect the programming cable to the transmitter and then to the **Transmitter Programming Port** on the FA464DR.
5. Press the transmitter reset button. (Refer to.) When the transmitter is successfully programmed, the receiver will emit a single "deedle" tone and the **Programming LED** will be on solid. (It may be necessary to press the transmitter reset button more than once, if the receiver is "busy" with signals from other transmitters.)

With the FA116 programmer: Up to 64 transmitters can be selected, programmed and deleted. The programmer allows installers to configure receiver parameters and output options. Point status and signal strength can be observed. Receiver outputs can be activated for testing and faults can be cleared.

Refer to FA116 programming documentation.

Receiver Operation:

Fault output operation: By default, the **Global Fault Output** will activate upon recognition of a trouble condition. Tamper and Low Battery signals will cause the **Global Fault Output** to latch. Inactive conditions will follow the current state of the transmitter.

A point is declared inactive as follows: The receiver looks for at least one supervisory transmission (or "check-in") from each supervised transmitter during the period of time programmed as the supervisory window. The first time the receiver gets a supervisory signal from a transmitter within a new window, it considers the transmitter active for the remainder of the window. If it fails to get another signal in the *following* supervisory window, it declares the point inactive at the end of that window. The actual time between a transmitter becoming inactive and being reported inactive will range from slightly more than the supervisory window value to slightly less than twice the window period. For example, the default supervisory window is 4 hours. If a transmitter becomes inactive, the inactive fault output will be triggered in 4 to 8 hours.

Note: *If another output is assigned a global fault function, such as global tamper, that function will no longer be reported at the Global Fault output.*

Displaying fault and active conditions: Faults can be identified by point and type. Press the **Review Button** while observing the status LEDs. Trouble conditions will be indicated by LEDs and the point will be shown on the **Transmitter Number Display**. The display will show multiple faults, by stepping through each trouble type in sequence, showing points affected. If a point is activated and/or has a trouble condition, the **Output LEDs** will indicate which output is assigned to the activated and/or troubled point.

Resetting outputs: All outputs can be reset either by pressing the **Reset Button** or by pulling the **Reset Input** terminal to ground. This can be done by installing a switch between the reset input and the ground terminal on the receiver. (*NOTE: The distance to this switch must not exceed 25 feet*). Remote or automatic resetting can be accomplished by relay control from some hardwire panels. **All** outputs are cleared. If a transmitter remains in alarm or if a fault condition is not corrected, the output will reactivate at the next supervisory signal received from the transmitter.

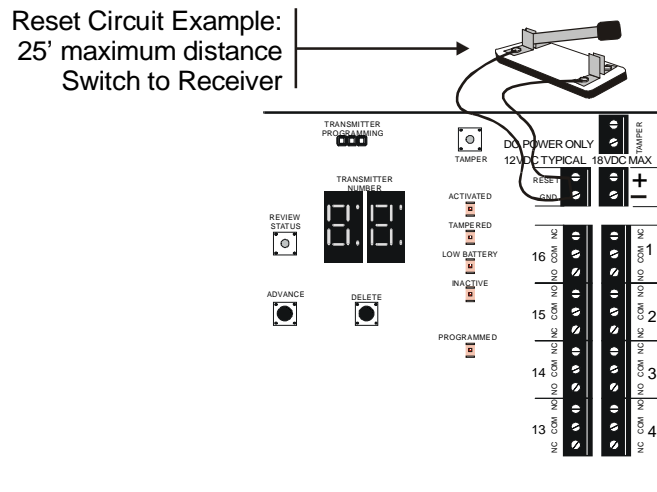

Figure 4

Deleting points: Transmitter programming information remains in non-volatile receiver memory. Transmitters may be re-programmed using the current parameters.

1. Use the **Advance Button** to show the desired point on the **Transmitter Number Display**.
2. Press the **Delete Button** on the FA464DR board. A 3-tone signal will be heard. The **Programmed LED** will change from steady "on" to flashing.
3. Points may also be deleted via the FA116 programmer.

Using the FA116 programmer keypad: Program all 64 points with FA116 programmer. Options which may be programmed include end-of-line resistor, internal contact (widegap magnet), changing external switch configuration, check-in time interval and desired output channel. In addition, receiver parameters may be set also, including supervisory window. See

Restoring factory defaults: This sequence restores all factory defaults and clears all programmed points.

Note: This sequence resets the receiver access code to default value (3446).

1. Press and hold the **Advance Button**.
2. Press and release the **Reset Button**. A steady tone will begin.
3. Release the **Advance Button**. The **Decode** and **Valid Decode LEDs** will go out.
4. Press and hold the **Delete Button**.
5. When a rapid "deedle- deedle- deedle" tone is heard and the **Decode LED** flashes, release the **Delete Button**.

Troubleshooting Guide:

◆ **The transmitter is programmed, but is not tripping the output.**

- Program the transmitter again.
- If you have an FA116 programmer, check the output assignment.
- Make sure that you are using an "FA" transmitter.
- Test the transmitter battery.
- Has the system ID been changed since the transmitter was programmed?

◆ **An output other than the one shown in Appendix A is activated.**

- The receiver's output configuration may have been reprogrammed.
- The transmitter may not be programmed to the correct point.

◆ **What does resetting the transmitter do?**

- Resetting the transmitter recovers the parameters last programmed into the transmitter. It does not erase the programming or cause the transmitter to stop transmitting.

◆ **How do I stop the transmitter from transmitting?**

- Remove the battery.

◆ **Does resetting the receiver to factory defaults delete all programmed points too?**

- Yes.

◆ **The Fault Output does not activate when the transmitter is tampered.**

- Check output setup programming. The output for the transmitter may be **Alarm + Tamper**.

◆ **The Alarm Output does not stay on when the transmitter is tripped.**

- Alarm outputs may be programmed for momentary activation.
- There may be more than one transmitter programmed to one point.
- If the transmitter is an FA206, an FA204 or an FA207, the transmitter sends a restoral right after the alarm. (The PIR sends a restoral, then goes to sleep for 90 seconds.)

◆ **The fault LED is staying on. What is wrong?**

- Press the Review Status button to see the point number and type of fault. Unless changed with an FA116 programmer, Low Battery and Tamper Conditions will latch the fault output until the receiver reset button is pressed. Once the cause of the fault had been determined and corrected, press the receiver reset button.

Appendix A (Continued)

DefaultFA464DR Transmitter Parameters

<u>Point#</u>	<u>Contact</u>	<u>Output</u>	<u>Check-In</u>	<u>Point#</u>	<u>Contact</u>	<u>Output</u>	<u>Check-In</u>
1	N/O	1	60 SEC	33	N/C	9	60 SEC
2	N/O	2	60 SEC	34	N/C	9	60 SEC
3	N/C	3	60 SEC	35	N/C	9	60 SEC
4	N/C	4	60 SEC	36	N/C	9	60 SEC
5	N/O	1	60 SEC	37	N/C	10	60 SEC
6	N/O	2	60 SEC	38	N/C	10	60 SEC
7	N/O	3	60 SEC	39	N/C	10	60 SEC
8	N/O	4	60 SEC	40	N/C	10	60 SEC
9	N/C	1	60 SEC	41	N/O	11	60 SEC
10	N/C	2	60 SEC	42	N/O	11	60 SEC
11	N/C	3	60 SEC	43	N/O	11	60 SEC
12	N/C	4	60 SEC	44	N/O	11	60 SEC
13	N/C	1	60 SEC	45	N/O	12	60 SEC
14	N/C	2	60 SEC	46	N/O	12	60 SEC
15	N/C	3	60 SEC	47	N/O	12	60 SEC
16	N/C	4	60 SEC	48	N/O	12	60 SEC
17	N/C	5	60 SEC	49*	N/O	13	5 MIN
18	N/C	5	60 SEC	50	N/O	13	5 MIN
19	N/C	5	60 SEC	51	N/O	13	5 MIN
20	N/C	5	60 SEC	52	N/O	13	5 MIN
21	N/C	6	60 SEC	53	N/O	14	5 MIN
22	N/C	6	60 SEC	54	N/O	14	5 MIN
23	N/C	6	60 SEC	55	N/O	14	5 MIN
24	N/C	6	60 SEC	56	N/O	14	5 MIN
25	N/C	7	60 SEC	57	N/O	15	5 MIN
26	N/C	7	60 SEC	58	N/O	15	5 MIN
27	N/C	7	60 SEC	59	N/O	15	5 MIN
28	N/C	7	60 SEC	60	N/O	15	5 MIN
29	N/C	8	60 SEC	61**	N/O+INT	16	60 SEC
30	N/C	8	60 SEC	62	N/O+INT	16	60 SEC
31	N/C	8	60 SEC	63	N/O+INT	16	60 SEC
32	N/C	8	60 SEC	64	N/O+INT	16	60 SEC

*Note: Points 49-60 are programmed to check in every five minutes. This will extend battery life slightly depending on which transmitter is used and the environment in which it operates. (For example, motion or door transmitters in high traffic areas have shorter battery life expectancies than similar transmitters which are seldom activated.)

**Note: Points 61 through 64 are configured to use widegap magnet contacts on FA200W or FA210W transmitters. (Normally Open external contacts plus Internal Contact = Yes)

Appendix B

Frequency Agile Series Transmitter Programming

FA210 Universal Transmitter

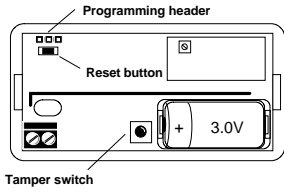

Program contacts: N/O or N/C, as needed
 EOL resistor: as needed
 Typical battery life: 4 years
 Battery type: 3.0V lithium DL123A
 Switch trigger: 1.5 seconds, minimum
 Dimensions: 3.55" x 1.70" x 0.920"

FA210W Universal Widegap Transmitter

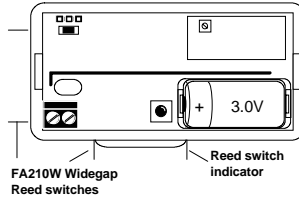

Program contacts: N/O or N/C, as needed
 EOL resistor: as needed
 Internal contact: as needed
 Typical battery life: 4 years
 Battery type: 3.0V lithium DL123A
 Switch trigger: 1.5 seconds, minimum
 Dimensions: 3.55" x 1.70" x 0.920"

FA202 Smoke Detector

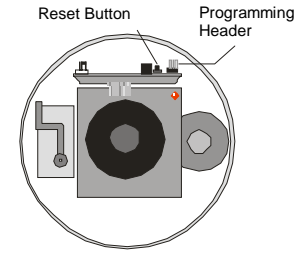

Program contacts: N/C
 Typical battery life: 1 year
 2 Batteries: 3V lithium
 Dimensions: 6.0" Diameter

Note: Remove jumper to program, replace jumper after programming.

FA203 Pendant Transmitter

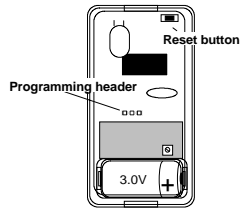

Program contacts: N/O
 Typical battery life: 3-5 years
 Battery (or equivalent): 3.0V lithium Sanyo CR2
 Dimensions: 3.10" x 1.62" x 0.750"

* To extend battery life, actual check-in interval of the FA203 is 2 to 3 times the programmed value.

FA204 Pendant Transmitter

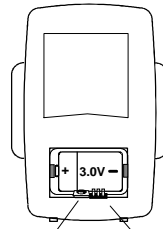

Note: Remove battery cover to access Reset Button and Programming Head

Program contacts: N/O
 Typical battery life: 2 years
 Battery: 3.0V Sanyo LiMn CR14250
 Dimensions: 2.8" x 1.7" x 0.83"

FA205 Beltclip Transmitter

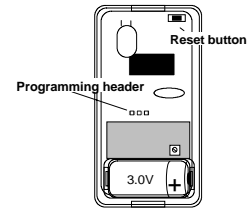

Program contacts: N/O
 Typical battery life: 3-5 years
 Battery (or equivalent): 3.0V lithium Sanyo CR2
 Dimensions: 3.10" x 1.62" x 0.750"

* To extend battery life, actual check-in interval of the FA205 is 2 to 3 times the programmed value.

FA206S PIR Motion Detector

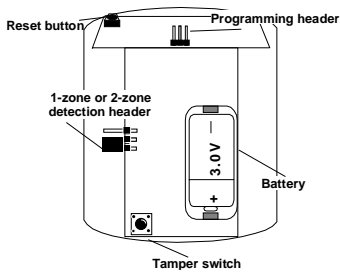

Program contacts: N/C
 Typical battery life: 2 years
 Battery: 3.0V lithium Duracell DL123A
 Sleep after trip: 90-103 seconds
 Dimensions: 3.75" x 2.88" x 2.40"

FA206DS PIR Motion Detector

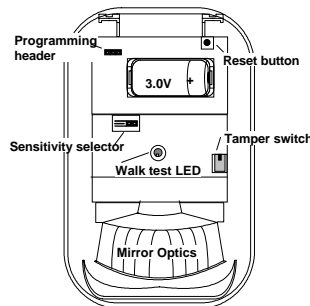

Program contacts: N/C
 Typical battery life: 2 years
 Battery: 3.0V lithium DL123A
 Sleep after trip: 180 seconds
 Dimensions: 3.75" x 5.75" x 2.50"

FA207 Glassbreak Detector

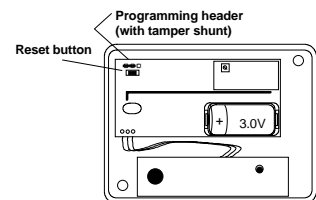

Program contacts: N/O
 Typical battery life: 2 years
 Battery: 3.0V lithium DL123A
 Dimensions: 4.25" x 3.12" x 1.63"

Note: Remove jumper to program, replace jumper after programming.

Appendix B

Frequency Agile Series Transmitter Programming, continued

**FA209
Billtrap Transmitter**

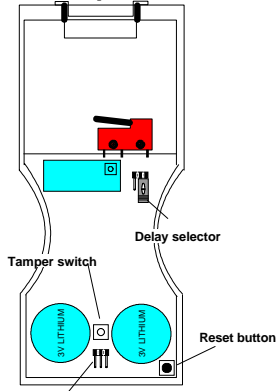

Programming header:
 Program contacts: N/O
 EOL, internal contacts: No
 Typical battery life: 1-2 years
 Battery type (Qty. 2): 3.0V lithium CR2450N
 Dimensions: 2.63" x 6.19" x 0.750"

**FA250
High Power Transmitter**

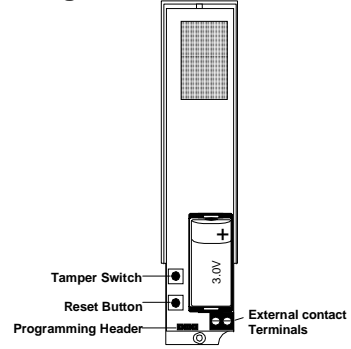

Program contacts: N/O or N/C, as needed
 EOL resistor: as needed
 Typical battery life: 1-2 years
 Battery type: 3.0V lithium DL123A
 Switch trigger: 1.5 seconds, minimum
 Dimensions: 1.25" x 6.00" x 0.750"

Note: Batteries are always supervised. Lithium batteries are capacity-tested at 18-hour intervals.
 Typical battery life is based on 60-second check-in.
 Transmitters will deactivate 2 weeks after low battery is detected.

Appendix C

FA464 PROGRAMMING WORKSHEET

DATE: _____

FILLED OUT BY: _____

COMPANY: _____

PROGRAMMED BY: _____

ADDRESS: _____

CITY: _____

PHONE: _____

ATTN: _____

Default Receiver Output Parameters

Output	Default Active on	Alarm Low Battery Tamper+Inactive Disabled	<u>CHOICES</u> Alarm+Tamper Inactive Low Battery+ Inactive	Tamper Tamper+Low Battery Any Tx fault
1 - 16	Alarm			

Default Transmitter Output mode

Condition	Default Mode	Follower	<u>CHOICES</u> Momentary	Latching
Alarm	Follower	Follower	Momentary	Latching
Inactive	Follower	Follower	Momentary	Latching
Tamper	Latching	Follower	Momentary	Latching
Low Batt	Latching	Follower	Momentary	Latching

Default Momentary Output time: **4 seconds**
 Programmable Output time: **1 - 16 seconds**

CHOICE: _____ seconds

Default Receiver Parameters

Programmable Options

CHOICE

System ID:	(random)	0 - 255	_____
Point supervision:	Yes	Yes / No	_____
Supervision window:	4 hours	1 - 99 minutes, 1 - 99 hours	_____
Access code:	3446	0000 - 9999	_____
Vision Plus compatible:	No	(See FA116 user manual) Yes / No	_____

Default Transmitter Parameters

- External Contacts options: **N/O or N/C**
- 2.2K EOL resistor options: **Yes or No (in external contact loop)**
- Internal Contact options: **Yes or No (FA200W and FA210W widegap only)**
- Output channel options: **1 - 16**
- Check-In interval options: **Unsupervised / 10, 30 or 60 seconds / 5 or 60 minutes / 8 or 18 hours**

Transmitter Programming

Point#	External Contact	<u>DEFAULT</u>		Output#	Check-in	<u>CHOICE</u>		Output#	Check-in (HR/SEC)
		EOL	Internal Contact			External Contact	EOL		
1	N/O	No	No	1	60 SEC				
2	N/O	No	No	2	60 SEC				
3	N/C	No	No	3	60 SEC				
4	N/C	No	No	4	60 SEC				
5	N/O	No	No	1	60 SEC				
6	N/O	No	No	2	60 SEC				
7	N/O	No	No	3	60 SEC				
8	N/O	No	No	4	60 SEC				
9	N/C	No	No	1	60 SEC				
10	N/C	No	No	2	60 SEC				
11	N/C	No	No	3	60 SEC				
12	N/C	No	No	4	60 SEC				
13	N/C	No	No	1	60 SEC				
14	N/C	No	No	2	60 SEC				
15	N/C	No	No	3	60 SEC				
16	N/C	No	No	4	60 SEC				

Transmitter Programming (Continued)

<u>Point#</u>	<u>External Contact</u>	<u>DEFAULT Internal</u>		<u>Output#</u>	<u>Check-in</u>	<u>External Contact</u>	<u>CHOICE Internal</u>		<u>Output#</u>	<u>Check-in (HR/SEC)</u>
		<u>EOL</u>	<u>Contact</u>				<u>EOL</u>	<u>Contact</u>		
17	N/C	No	No	5	60 SEC					
18	N/C	No	No	5	60 SEC					
19	N/C	No	No	5	60 SEC					
20	N/C	No	No	5	60 SEC					
21	N/C	No	No	6	60 SEC					
22	N/C	No	No	6	60 SEC					
23	N/C	No	No	6	60 SEC					
24	N/C	No	No	6	60 SEC					
25	N/C	No	No	7	60 SEC					
26	N/C	No	No	7	60 SEC					
27	N/C	No	No	7	60 SEC					
28	N/C	No	No	7	60 SEC					
29	N/C	No	No	8	60 SEC					
30	N/C	No	No	8	60 SEC					
31	N/C	No	No	8	60 SEC					
32	N/C	No	No	8	60 SEC					
33	N/C	No	No	9	60 SEC					
34	N/C	No	No	9	60 SEC					
35	N/C	No	No	9	60 SEC					
36	N/C	No	No	9	60 SEC					
37	N/C	No	No	10	60 SEC					
38	N/C	No	No	10	60 SEC					
39	N/C	No	No	10	60 SEC					
40	N/C	No	No	10	60 SEC					
41	N/O	No	No	11	60 SEC					
42	N/O	No	No	11	60 SEC					
43	N/O	No	No	11	60 SEC					
44	N/O	No	No	11	60 SEC					
45	N/O	No	No	12	60 SEC					
46	N/O	No	No	12	60 SEC					
47	N/O	No	No	12	60 SEC					
48	N/O	No	No	12	60 SEC					
49*	N/O	No	No	13	5 MIN					
50	N/O	No	No	13	5 MIN					
51	N/O	No	No	13	5 MIN					
52	N/O	No	No	13	5 MIN					
53	N/O	No	No	14	5 MIN					
54	N/O	No	No	14	5 MIN					
55	N/O	No	No	14	5 MIN					
56	N/O	No	No	14	5 MIN					
57	N/O	No	No	15	5 MIN					
58	N/O	No	No	15	5 MIN					
59	N/O	No	No	15	5 MIN					
60	N/O	No	No	15	5 MIN					
61**	N/O	No	Yes	16	60 SEC					
62	N/O	No	Yes	16	60 SEC					
63	N/O	No	Yes	16	60 SEC					
64	N/O	No	Yes	16	60 SEC					

* Note: Points 49-60 are default-programmed to check in every five minutes. This will extend battery life slightly depending on which transmitter is used.

** Note: Points 61-64 are default-programmed to be Normally Open plus Internal Contact (FA200W and FA210W widegap magnet contacts) set to "Yes".

Appendix D

Warranty & Disclaimer

Inovonics Wireless Corporation ("Inovonics") warrants its products ("Product" or "Products") to conform to its own specifications and to be free of defects in materials and workmanship under normal use for a period of twenty-four (24) months from the date of manufacture. Within the warranty period Inovonics will repair or replace, at its option, all or any part of the warranted product. Inovonics will not be responsible for dismantling and/or reinstallation charges. To exercise the warranty, the User ("User", "Installer" or "Consumer") must be given a Return Material Authorization ("RMA") Number by Inovonics. Details of shipment will be arranged at that time.

This warranty does not apply in cases of improper installation, misuse, failure to follow installation and operating instructions, alteration, abuse, accident or tampering, and repair by anyone other than Inovonics.

This warranty is exclusive and expressly in lieu of all other warranties, obligations or liabilities, whether written, oral, express, or implied, including any warranty of merchantability or fitness for a particular purpose. Inovonics will not be liable to anyone for any consequential or incidental damages for breach of this warranty or any other warranties.

This warranty will not be modified, varied or extended. Inovonics does not authorize any person to act on its behalf to modify, vary or extend this warranty. This warranty will apply to Inovonics Products only. All other products, accessories or attachments used in conjunction with Inovonics equipment, including batteries, will be covered solely by their own warranty, if any. Inovonics will not be liable for any direct, incidental or consequential damage or loss whatsoever, caused by the malfunction of Product due to products, accessories, or attachments of other manufacturers, including batteries, used in conjunction with Inovonics Products.

This warranty does not warrant the replacement of batteries that are used to power Inovonics Products.

The User recognizes that a properly installed and maintained security system may only reduce the risk of events such as burglary, robbery, personal injury and fire. It does not insure or guarantee that there will be no death, personal damage and/or damage to property as a result. **Inovonics does not claim that the Product may not be compromised and/or circumvented, or that the Product will prevent any death, personal and/or bodily injury and/or damage to property resulting from burglary, robbery, fire or otherwise, or that the Product will in all cases provide adequate warning or protection.**

Inovonics shall have no liability for any death, injury or damage, however incurred, based on a claim that Inovonics Products failed to function. However, if Inovonics is held liable, directly or indirectly, for any loss or damage arising under this limited warranty or otherwise, regardless of cause or origin, Inovonics' maximum liability will not in any case exceed the purchase price of the Product, which will be fixed as liquidated damages and not as a penalty, and will be the complete and exclusive remedy against Inovonics.

Warning: The User should follow all installation, operation and maintenance instructions. The User is strongly advised to conduct Product and systems tests at least once each week. Changes in environmental conditions, electric or electronic disruptions and tampering, may cause the Product to not perform as expected.



Warning: Inovonics warrants its Product to the User. The User is responsible for exercising all due prudence and taking necessary precautions for the safety and protection of lives and property wherever Inovonics Products are installed. Inovonics strongly advises the User to program Products to be supervised whenever used in applications affecting life safety. Users are warned that unsupervised devices are subject to undetected failure due to malfunction, battery failure, tampering, or changes in environment.



***Frequency Agile*[®] Receivers
from *Inovonics*:**

FA401	Single Channel / Single Output
FA401R	Single Channel / Single Relay Output
FA404	4-Transmitter / Single Output
FA404R	4-Transmitter / Single Relay Output
FA416	16-channel / 4-output
FA416D	16-channel / 4-output with display
FA416R	16-channel / 4-relay output
FA416DR	16-channel / 4-relay output with display
FA464DR	64-channel / 16-relay output with display

Receiver Accessories:

FA116	Executive Programmer for FA416 /FA464DR/ C404
FA516	Display module for FA416 and FA416R
FA541	Single-channel form 'C' relay module

**Inovonics Wireless Corporation
315 CTC Blvd
Louisville CO 80027
Phone (800)782-2709
FAX: (303)939-8977
E-MAIL: support@inovonics.com**

www.inovonics.com