

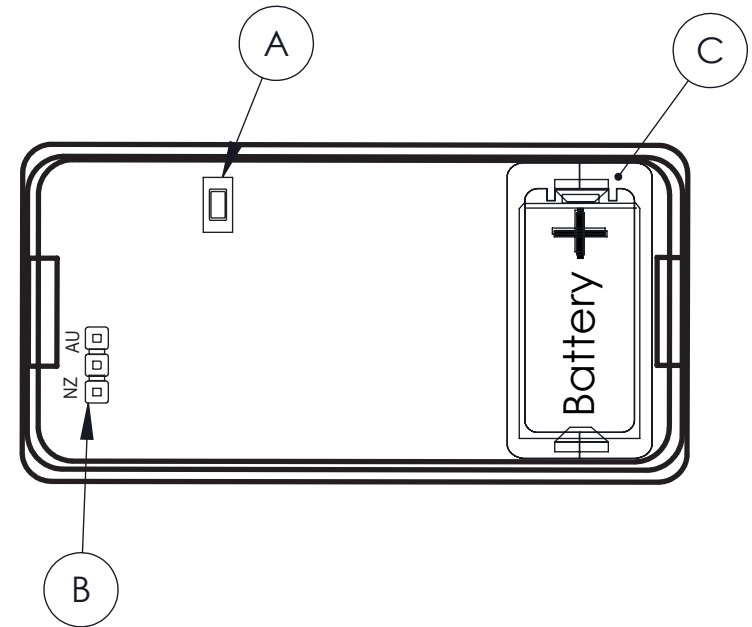

REVISIONS

REV.	DESCRIPTIONS	DATE	ECO
1	Release For Production	11/20/2017	

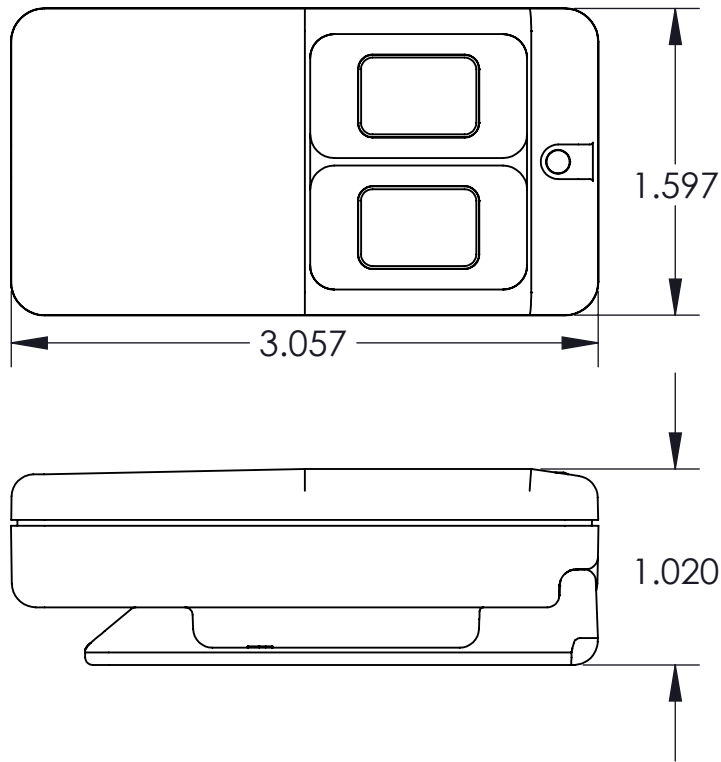

- A** Reset button
- B** Frequency band selection pins
- C** Battery

Copyright 2017 Inovonics Corp. All rights reserved. Drawings are the property of Inovonics Corp.		 WWW.INOVONICS.COM
CAD GENERATED DRAWING, DO NOT MANUALLY UPDATE OR SCALE DRAWING. UNLESS OTHERWISE SPECIFIED		
TOLERANCE:	XXX=+/- .005 XX=+/- .010	DESCRIPTION: DEALER DRAWING-EN1238D
AUTHOR:	NJ	PART NO: 06941
DRAWN DATE:	11/20/2017	SCALE: N/A SIZE: A SHEET 1 OF 1